

Tangents to Circles

Determine if line AB is tangent to the circle.

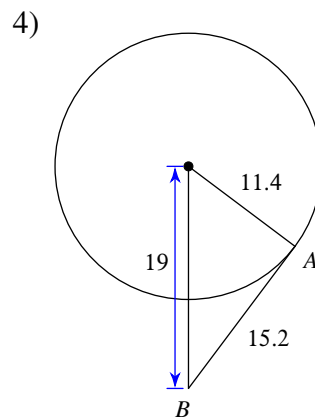

Find the segment length indicated. Assume that lines which appear to be tangent are tangent.

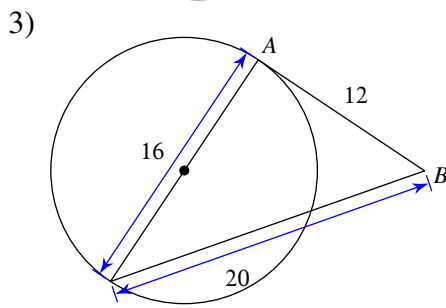
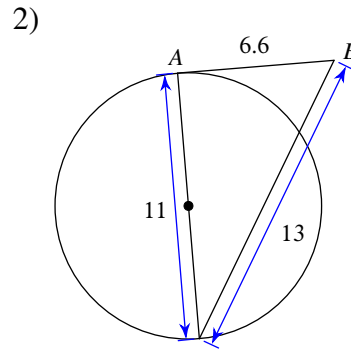
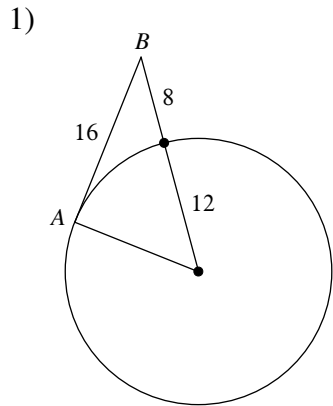
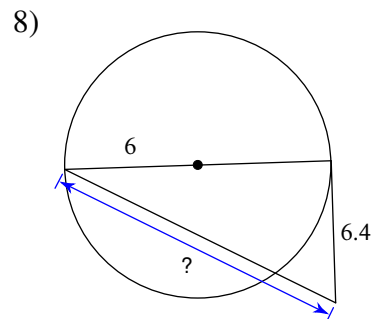
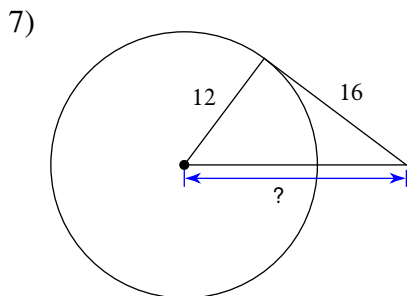
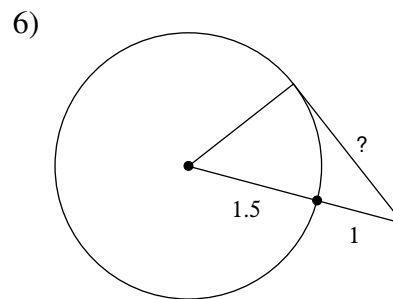
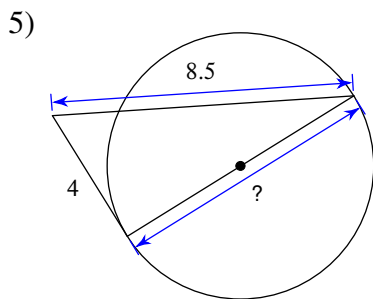

Find the perimeter of each polygon. Assume that lines which appear to be tangent are tangent.

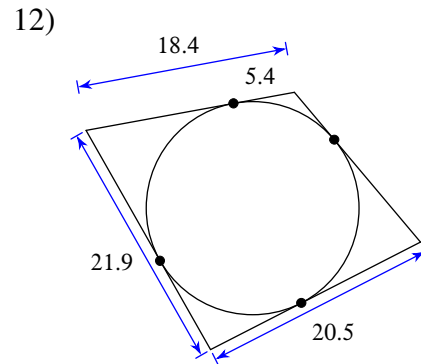
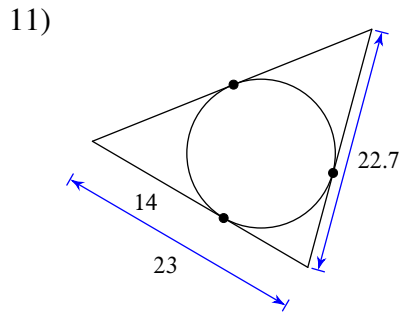
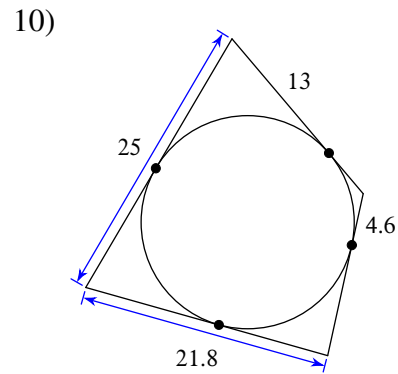
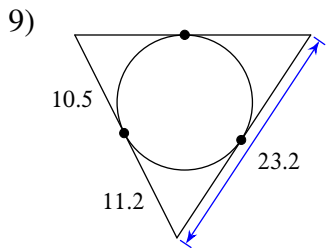

Find the angle measure indicated. Assume that lines which appear to be tangent are tangent.

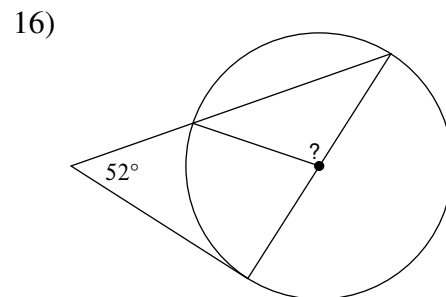
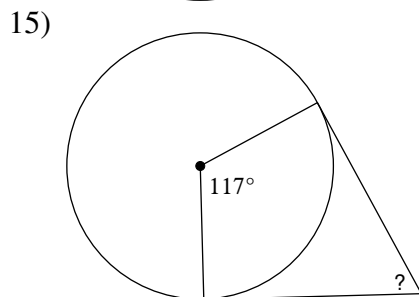
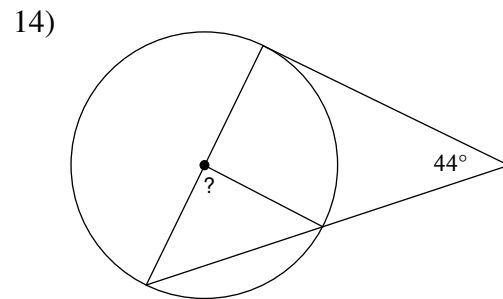
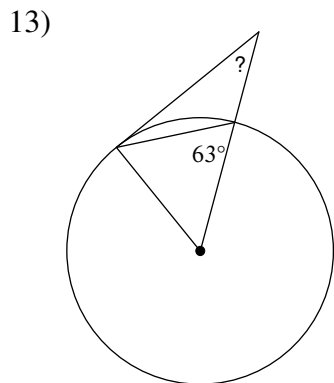

Solve for x . Assume that lines which appear to be tangent are tangent.

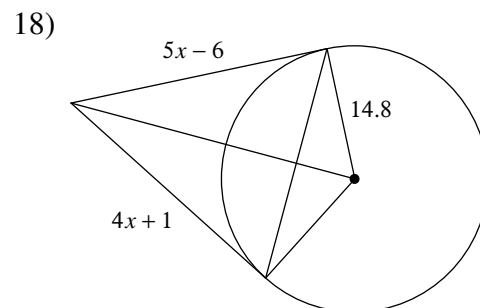
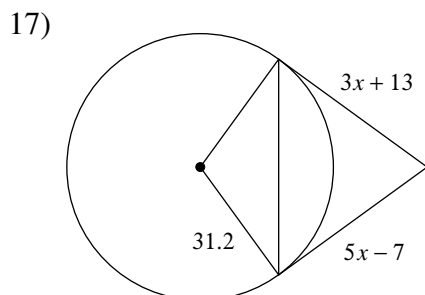

Tangents to Circles

Determine if line AB is tangent to the circle.

1) **Tangent**

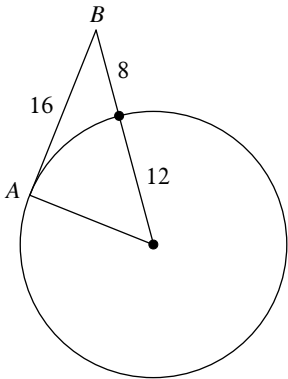

2) **Not tangent**

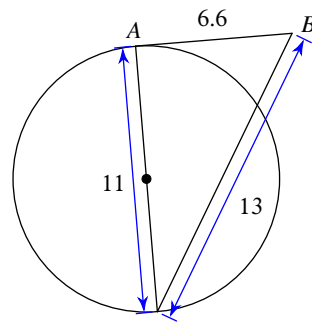

3) **Tangent**

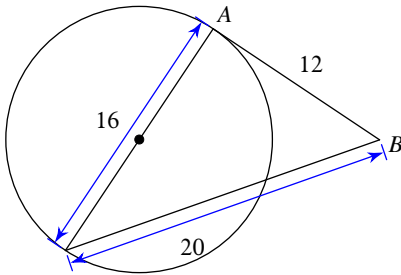

4) **Tangent**

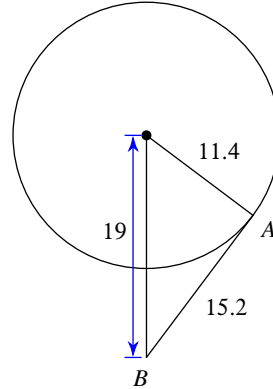

Find the segment length indicated. Assume that lines which appear to be tangent are tangent.

5) **7.5**

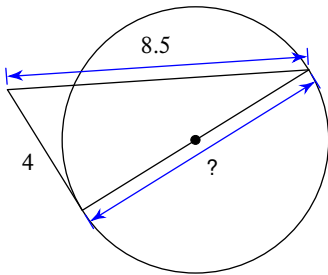

6) **2**

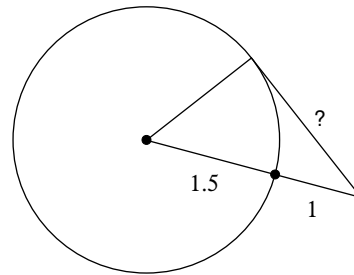

7) **20**

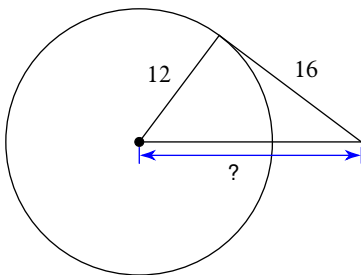

8) **13.6**

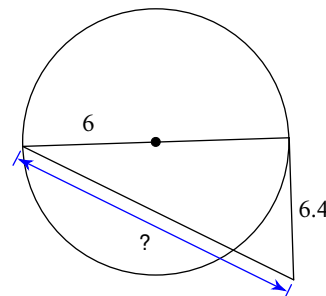

Find the perimeter of each polygon. Assume that lines which appear to be tangent are tangent.

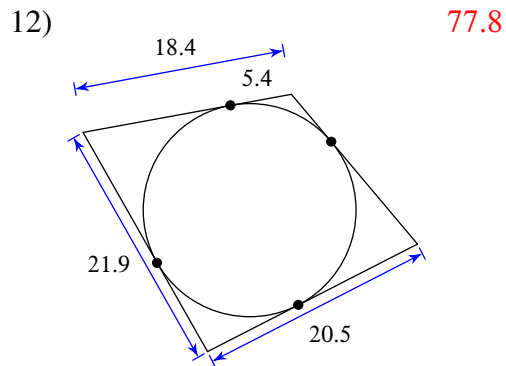
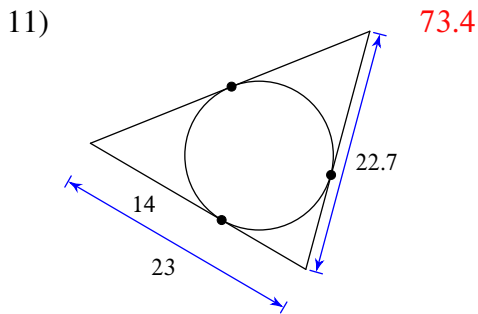
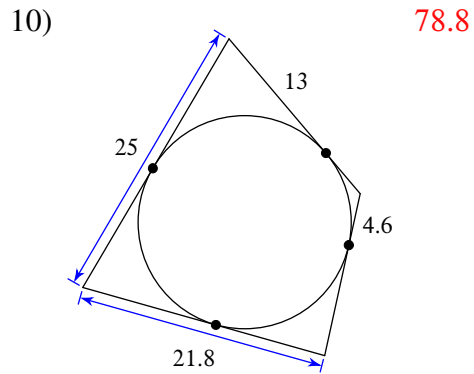
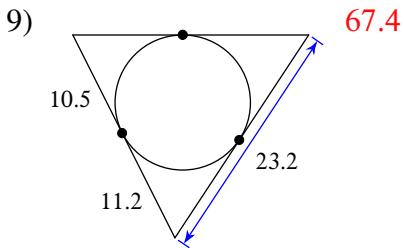

Find the angle measure indicated. Assume that lines which appear to be tangent are tangent.

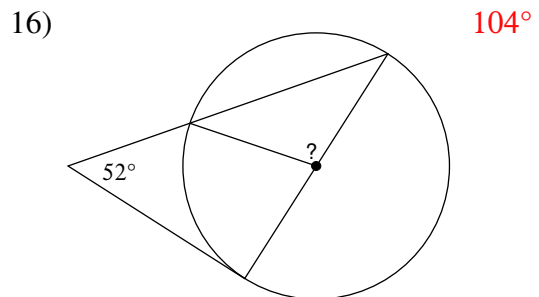
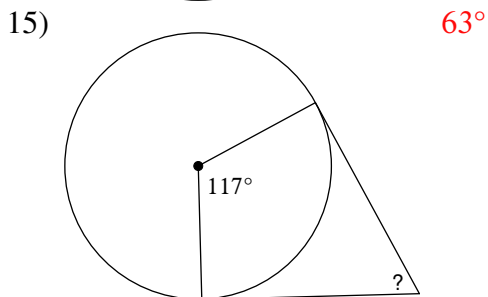
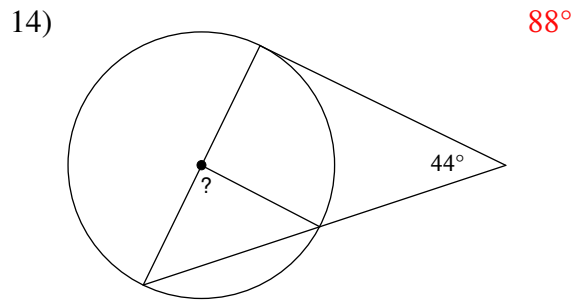
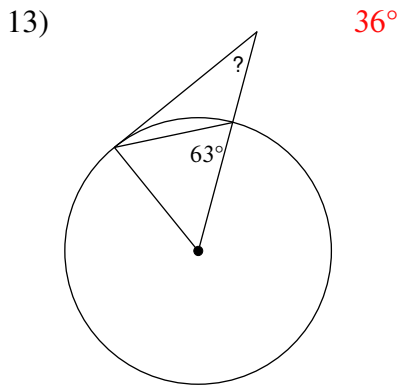

Solve for x . Assume that lines which appear to be tangent are tangent.

